

// The safety
lock against backflow,
without O-Ring,
for Aseptic applications



CHECK VALVES



ART. 048
Check Valves

P. 070



ART. 001
Check Valves
Gas Threaded

P. 072



ART. 002
Adjustable Check Valves
Gas Threaded

P. 074

Characteristics. Art. 048: Designed for Aseptic and High Purity Applications. Internal design free from entrapment areas and without asymptotic seals, no screws or threadings or O-Rings inside the valve. PTFE piston full machined from solid and extra-soft AISI 316L spring. **Art. 001:** Valve body machined from solid, no middle connections. The closure area is between the 2 support points of the piston. **Art. 002:** Valve body machined from solid. Adjustable minimum opening pressure by external screw regulation.

Documentation. Laser marking for traceability and validation processes. Material 3.1 certificates, FDA or USP. Internal surface finishing check as standard (only for Art.048).



ASTM A270 Tri-Clamp - Flange design according to ASME-BPE

Size	Ø A	Ø B	L	Body Material	Gasket Material	Code
1/2"	25,00	9,40	70,00	1.4404	PTFE - USP 70	048Z60050PT70
					PTFE - USP 121	048Z60050PT121
				1.4435-BN2	PTFE - USP 70	048Z50050PT70
					PTFE - USP 121	048Z50050PT121
3/4"	25,00	15,75	70,00	1.4404	PTFE - USP 70	048Z60075PT70
					PTFE - USP 121	048Z60075PT121
				1.4435-BN2	PTFE - USP 70	048Z50075PT70
					PTFE - USP 121	048Z50075PT121
1"	50,50	22,10	85,00	1.4404	PTFE - USP 70	048Z60100PT70
					PTFE - USP 121	048Z60100PT121
				1.4435-BN2	PTFE - USP 70	048Z50100PT70
					PTFE - USP 121	048Z50100PT121
1.1/2"	50,50	34,80	90,00	1.4404	PTFE - USP 70	048Z60150PT70
					PTFE - USP 121	048Z60150PT121
				1.4435-BN2	PTFE - USP 70	048Z50150PT70
					PTFE - USP 121	048Z50150PT121
2"	64,00	47,50	125,00	1.4404	PTFE - USP 70	048Z60200PT70
					PTFE - USP 121	048Z60200PT121
				1.4435-BN2	PTFE - USP 70	048Z50200PT70
					PTFE - USP 121	048Z50200PT121
2.1/2"	77,40	60,20	125,00	1.4404	PTFE - USP 70	048Z60250PT70
					PTFE - USP 121	048Z60250PT121
				1.4435-BN2	PTFE - USP 70	048Z50250PT70
					PTFE - USP 121	048Z50250PT121

Int. finishing: **Ra ≤ 0,4 µm**
Ext. finishing: **Ra ≤ 0,8 µm Mirror Polished**

Max Working Conditions:
10 bar (120 psi) and 150°C (300°F)

Gaskets:
USP CLASS VI - 70° PTFE
or **USP CLASS VI - 121° PTFE**

Minimum opening pressure - Indicative data only

Horizontal assembly

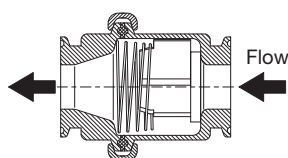

Vertical assembly - Rising flow

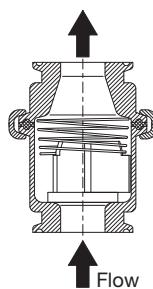

Vertical assembly - Down flow

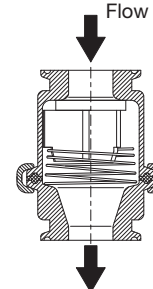

Size	BAR	PSI	KPA
1/2"	0,025	0,36	2,5
3/4"	0,020	0,29	2
1"	0,010	0,15	1
1.1/2"	0,010	0,15	1
2"	0,010	0,15	1
2.1/2"	0,010	0,15	1

Size	BAR	PSI	KPA
1/2"	0,030	0,44	3
3/4"	0,025	0,36	2,5
1"	0,025	0,36	2,5
1.1/2"	0,025	0,36	2,5
2"	0,025	0,36	2,5
2.1/2"	0,030	0,44	3

Size	BAR	PSI	KPA
1/2"	0,010	0,15	1
3/4"	0,010	0,15	1
1"	0,010	0,15	1
1.1/2"	0,010	0,15	1
2"	0,015	0,22	1,5
2.1/2"	0,015	0,22	1,5

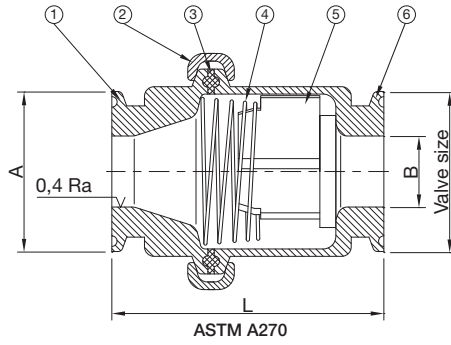

N°	Name	Material
1	Short Body	AISI 316L
2	Clamp	AISI 304
3	Clamp Gasket	PTFE*
4	Spring	AISI 316L or AISI 316
5	Piston	PTFE*
6	Long Body	AISI 316L

Flange accordig to Asme BPE
* FDA approved as standard

N°	Description	Valve size	Code
2	Clamp n° 1 pcs	1/2"	034Z40100
		3/4"	034Z40100
		1"	034Z40200
		1.1/2"	034Z40200
		2"	034Z40300
		2.1/2"	034Z40300
3	Tri-Clamp Gasket PTFE - USP 70° n° 1 pcs	1/2"	036Z0150PT70
		3/4"	036Z0150PT70
		1"	036Z0200PT70
		1.1/2"	036Z0200PT70
		2"	036Z0300PT70
		2.1/2"	036Z0300PT70
3	Tri-Clamp Gasket PTFE - USP 121° n° 1 pcs	1/2"	036Z0150PT121
		3/4"	036Z0150PT121
		1"	036Z0200PT121
		1.1/2"	036Z0200PT121
		2"	036Z0300PT121
		2.1/2"	036Z0300PT121
4	Spring n° 1 pcs	1/2"	0486005004
		3/4"	0486005004
		1"	0486010004
		1.1/2"	0486010004
		2"	0486020004
		2.1/2"	0486020004
5	Piston PTFE - USP 70° n° 1 pcs	1/2"	048X005005PT70
		3/4"	048X005005PT70
		1"	048X010005PT70
		1.1/2"	048X010005PT70
		2"	048X020005PT70
		2.1/2"	048X020005PT70
5	Piston PTFE - USP 121° n° 1 pcs	1/2"	048X005005PT121
		3/4"	048X005005PT121
		1"	048X010005PT121
		1.1/2"	048X010005PT121
		2"	048X020005PT121
		2.1/2"	048X020005PT121

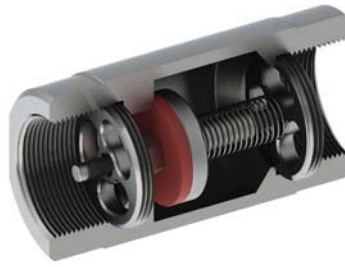

Female Gas Threaded BSPP

Size	Ø A	Ø B	L	Valve Material	Gasket Material	Code
1/4"	22,00	60,00	17,00	1.4404	FPM/FKM	001Z60025V
					EPDM	001Z60025EP
					PTFE - FDA	001Z60025PT70
					SILICONE FDA	001Z60025SIF
3/8"	25,00	65,00	20,00	1.4404	FPM/FKM	001Z60037V
					EPDM	001Z60037EP
					PTFE - FDA	001Z60037PT70
					SILICONE FDA	001Z60037SIF
1/2"	30,00	75,00	25,00	1.4404	FPM/FKM	001Z60050V
					EPDM	001Z60050EP
					PTFE - FDA	001Z60050PT70
					SILICONE FDA	001Z60050SIF
3/4"	38,00	80,00	32,00	1.4404	FPM/FKM	001Z60075V
					EPDM	001Z60075EP
					PTFE - FDA	001Z60075PT70
					SILICONE FDA	001Z60075SIF
1"	48,00	85,00	40,00	1.4404	FPM/FKM	001Z60100V
					EPDM	001Z60100EP
					PTFE - FDA	001Z60100PT70
					SILICONE FDA	001Z60100SIF
1.1/4"	60,00	90,00	50,00	1.4404	FPM/FKM	001Z60125V
					EPDM	001Z60125EP
					PTFE - FDA	001Z60125PT70
					SILICONE FDA	001Z60125SIF
1.1/2"	65,00	95,00	56,00	1.4404	FPM/FKM	001Z60150V
					EPDM	001Z60150EP
					PTFE - FDA	001Z60150PT70
					SILICONE FDA	001Z60150SIF
2"	75,00	105,00	66,00	1.4404	FPM/FKM	001Z60200V
					EPDM	001Z60200EP
					PTFE - FDA	001Z60200PT70
					SILICONE FDA	001Z60200SIF
2.1/2"	99,00	130,00	85,00	1.4404	FPM/FKM	001Z60250V
					EPDM	001Z60250EP
					PTFE - FDA	001Z60250PT70
					SILICONE FDA	001Z60250SIF

Int. finishing: $Ra \leq 1,6 \mu m$
 Ext. finishing: $Ra \leq 1,6 \mu m$

Valve body machined from solid, no middle connections. The closure area is between the 2 support points of the piston.

Max Working Conditions:
60 bar and (870 psi) and 150°C (300°F)

Gaskets:
FDA approved PTFE or FPM/FKM or EPDM or SILICONE

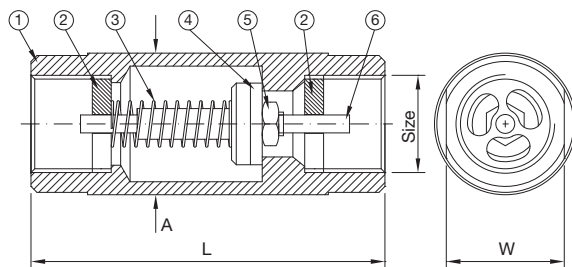

N°	Name	Material
1	Body	AISI 316L
2	Bearing	AISI 316L
3	Spring	AISI 316L or AISI 316
4	Gasket	FPM/FKM or EPDM or PTFE-FDA or SILICONE
5	Nut	AISI 316L
6	Piston	AISI 316L

N°	Description	Valve size	Code
2	Bearing n° 1 pcs	1/4"	0016002502
		3/8"	0016003702
		1/2"	0016005002
		3/4"	0016007502
		1"	0016010002
		1.1/4"	0016012502
		1.1/2"	0016015002
		2"	0016020002
3	Spring n° 1 pcs	1/4"	0016002503
		3/8"	0016003703
		1/2"	0016005003
		3/4"	0016007503
		1"	0016010003
		1.1/4"	0016012503
		1.1/2"	0016015003
		2"	0016020003
4	FPM/FKM Gasket n° 1 pcs	1/4"	001X002504V
		3/8"	001X003704V
		1/2"	001X005004V
		3/4"	001X007504V
		1"	001X010004V
		1.1/4"	001X012504V
		1.1/2"	001X015004V
		2"	001X020004V
4	EPDM Gasket n° 1 pcs	1/4"	001X002504EP
		3/8"	001X003704EP
		1/2"	001X005004EP
		3/4"	001X007504EP
		1"	001X010004EP
		1.1/4"	001X012504EP
		1.1/2"	001X015004EP
		2"	001X020004EP
4	PTFE-FDA Gasket n° 1 pcs	1/4"	001X002504PT70
		3/8"	001X003704PT70
		1/2"	001X005004PT70
		3/4"	001X007504PT70
		1"	001X010004PT70
		1.1/4"	001X012504PT70
		1.1/2"	001X015004PT70
		2"	001X020004PT70
4	SILICONE FDA Gasket n° 1 pcs	1/4"	001X002504SIF
		3/8"	001X003704SIF
		1/2"	001X005004SIF
		3/4"	001X007504SIF
		1"	001X010004SIF
		1.1/4"	001X012504SIF
		1.1/2"	001X015004SIF
		2"	001X020004SIF
5	Nut n° 1 pcs	1/4"	N-A4-M03-H024
		3/8"	N-A4-M04-H040
		1/2"	N-A4-M05-H040
		3/4"	N-A4-M06-H050
		1"	N-A4-M06-H050
		1.1/4"	N-A4-M08-H065
		1.1/2"	N-A4-M10-H060
		2"	N-A4-M10-H060
6	Piston n° 1 pcs	1/4"	0016002506
		3/8"	0016003706
		1/2"	0016005006
		3/4"	0016007506
		1"	0016010006
		1.1/4"	0016012506
		1.1/2"	0016015006
		2"	0016020006
6	Piston n° 1 pcs	2.1/2"	0016025006

N°	Description	Valve size	Code
2	Bearing n° 1 pcs	1/4"	0016002502
		3/8"	0016003702
		1/2"	0016005002
		3/4"	0016007502
		1"	0016010002
		1.1/4"	0016012502
		1.1/2"	0016015002
		2"	0016020002
3	Spring n° 1 pcs	1/4"	0016002503
		3/8"	0016003703
		1/2"	0016005003
		3/4"	0016007503
		1"	0016010003
		1.1/4"	0016012503
		1.1/2"	0016015003
		2"	0016020003
4	FPM/FKM Gasket n° 1 pcs	1/4"	001X002504V
		3/8"	001X003704V
		1/2"	001X005004V
		3/4"	001X007504V
		1"	001X010004V
		1.1/4"	001X012504V
		1.1/2"	001X015004V
		2"	001X020004V
4	EPDM Gasket n° 1 pcs	1/4"	001X002504EP
		3/8"	001X003704EP
		1/2"	001X005004EP
		3/4"	001X007504EP
		1"	001X010004EP
		1.1/4"	001X012504EP
		1.1/2"	001X015004EP
		2"	001X020004EP
4	PTFE-FDA Gasket n° 1 pcs	1/4"	001X002504PT70
		3/8"	001X003704PT70
		1/2"	001X005004PT70
		3/4"	001X007504PT70
		1"	001X010004PT70
		1.1/4"	001X012504PT70
		1.1/2"	001X015004PT70
		2"	001X020004PT70
4	SILICONE FDA Gasket n° 1 pcs	1/4"	001X002504SIF
		3/8"	001X003704SIF
		1/2"	001X005004SIF
		3/4"	001X007504SIF
		1"	001X010004SIF
		1.1/4"	001X012504SIF
		1.1/2"	001X015004SIF
		2"	001X020004SIF
5	Nut n° 1 pcs	1/4"	N-A4-M03-H024
		3/8"	N-A4-M04-H040
		1/2"	N-A4-M05-H040
		3/4"	N-A4-M06-H050
		1"	N-A4-M06-H050
		1.1/4"	N-A4-M08-H065
		1.1/2"	N-A4-M10-H060
		2"	N-A4-M10-H060
6	Piston n° 1 pcs	1/4"	0016002506
		3/8"	0016003706
		1/2"	0016005006
		3/4"	0016007506
		1"	0016010006
		1.1/4"	0016012506
		1.1/2"	0016015006
		2"	0016020006
6	Piston n° 1 pcs	2.1/2"	0016025006



Male Gas Threaded BSPP

Size	A	L	B	Valve Material	Gasket Material	Code
1/4"	27,50	105,00	23,00	1.4404	FPM/FKM + PTFE	002Z60025V+PT70
					SILICONE FDA	002Z60025SIF
3/8"	31,00	115,00	29,50	1.4404	FPM/FKM + PTFE	002Z60037V+PT70
					SILICONE FDA	002Z60037SIF
1/2"	37,00	133,00	36,00	1.4404	FPM/FKM + PTFE	002Z60050V+PT70
					SILICONE FDA	002Z60050SIF
3/4"	44,00	145,00	44,50	1.4404	FPM/FKM + PTFE	002Z60075V+PT70
					SILICONE FDA	002Z60075SIF
1"	51,00	165,00	50,00	1.4404	FPM/FKM + PTFE	002Z60100V+PT70
					SILICONE FDA	002Z60100SIF

Int. finishing: $Ra \leq 1,6 \mu m$
 Ext. finishing: $Ra \leq 1,6 \mu m$

Adjustable minimum opening pressure, turning the screw on the top of the valve.

Max Working Conditions:
150°C (300°F) - Check maximum pressure installation on the following product data sheet.

Gaskets:
FDA approved PTFE + FPM/FKM or SILICONE for lowest pressure applications

Regulating Opening Pressure

FPM/FKM + PTFE GASKETS		
Size	Minimum	Maximum
1/4"	1 bar / 14,5 PSI	3 bar / 43,5 PSI
3/8"	1 bar / 14,5 PSI	3 bar / 43,5 PSI
1/2"	1 bar / 14,5 PSI	10 bar / 145 PSI
3/4"	1 bar / 14,5 PSI	6 bar / 87,0 PSI
1"	1 bar / 14,5 PSI	6 bar / 87,0 PSI

SILICONE GASKETS		
Size	Minimum	Maximum
1/4"	0,5 bar / 7,3 PSI	1 bar / 14,5 PSI
3/8"	0,5 bar / 7,3 PSI	1 bar / 14,5 PSI
1/2"	0,5 bar / 7,3 PSI	1 bar / 14,5 PSI
3/4"	0,5 bar / 7,3 PSI	1 bar / 14,5 PSI
1"	0,5 bar / 7,3 PSI	1 bar / 14,5 PSI

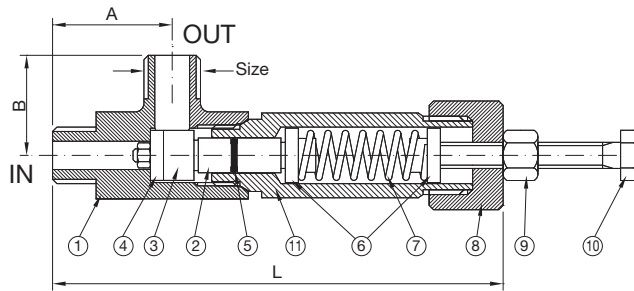

N°	Name	Material
1	Body	AISI 316L
2	Piston	AISI 316L
3	Gasket Support	AISI 316L
4	Gasket	PTFE or SILICONE FDA
5	O-Ring	FPM/FKM or SILICONE FDA
6	Spring Guide	AISI 316L
7	Spring	AISI 316L or AISI 316
8	Cap	AISI 316L
9	Nut	AISI 304
10	Screw	AISI 304
11	Piston Support	AISI 316L

N°	Description	Valve size	Code
2	Piston n° 1 pcs	1/4"	0026002502
		3/8"	0026003702
		1/2"	0026005002
		3/4"	0026007502
		1"	0026010002
3	Gasket Support n° 1 PCS	1/4"	0026002503
		3/8"	0026003703
		1/2"	0026005003
		3/4"	0026007503
		1"	0026010003
4+5	Gasket PTFE + O-Ring KIT FPM/FKM n° 1 + 1 pcs	1/4"	002X002545K1
		3/8"	002X003745K1
		1/2"	002X005045K1
		3/4"	002X007545K1
		1"	002X010045K1
4+5	Gasket Silicone + O-Ring KIT Silicone n° 1 + 1 pcs	1/4"	002X002545K2
		3/8"	002X003745K2
		1/2"	002X005045K2
		3/4"	002X007545K2
		1"	002X010045K2
7	Spring n° 1 pcs	1/4"	0026002507
		3/8"	0026003707
		1/2"	0026005007
		3/4"	0026007507
		1"	0026010007
9	Nut n° 1 pcs	1/4"	N-A2-M06-H050
		3/8"	N-A2-M08-H065
		1/2"	N-A2-M10-H060
		3/4"	N-A2-M10-H060
		1"	N-A2-M10-H060
10	Screw n° 1 pcs	1/4"	HSH-M06X40-A2
		3/8"	HSH-M08X40-A2
		1/2"	HSH-M10X60-A2
		3/4"	HSH-M10X60-A2
		1"	HSH-M10X60-A2
11	Piston support n° 1 pcs	1/4"	0026002511
		3/8"	0026003711
		1/2"	0026005011
		3/4"	0026007511
		1"	0026010011