

ASEPTIC DIAPHRAGM VALVES

// The state of the art
without asymptotic seal,
born for Aseptic
and High Purity Applications

ADV
A

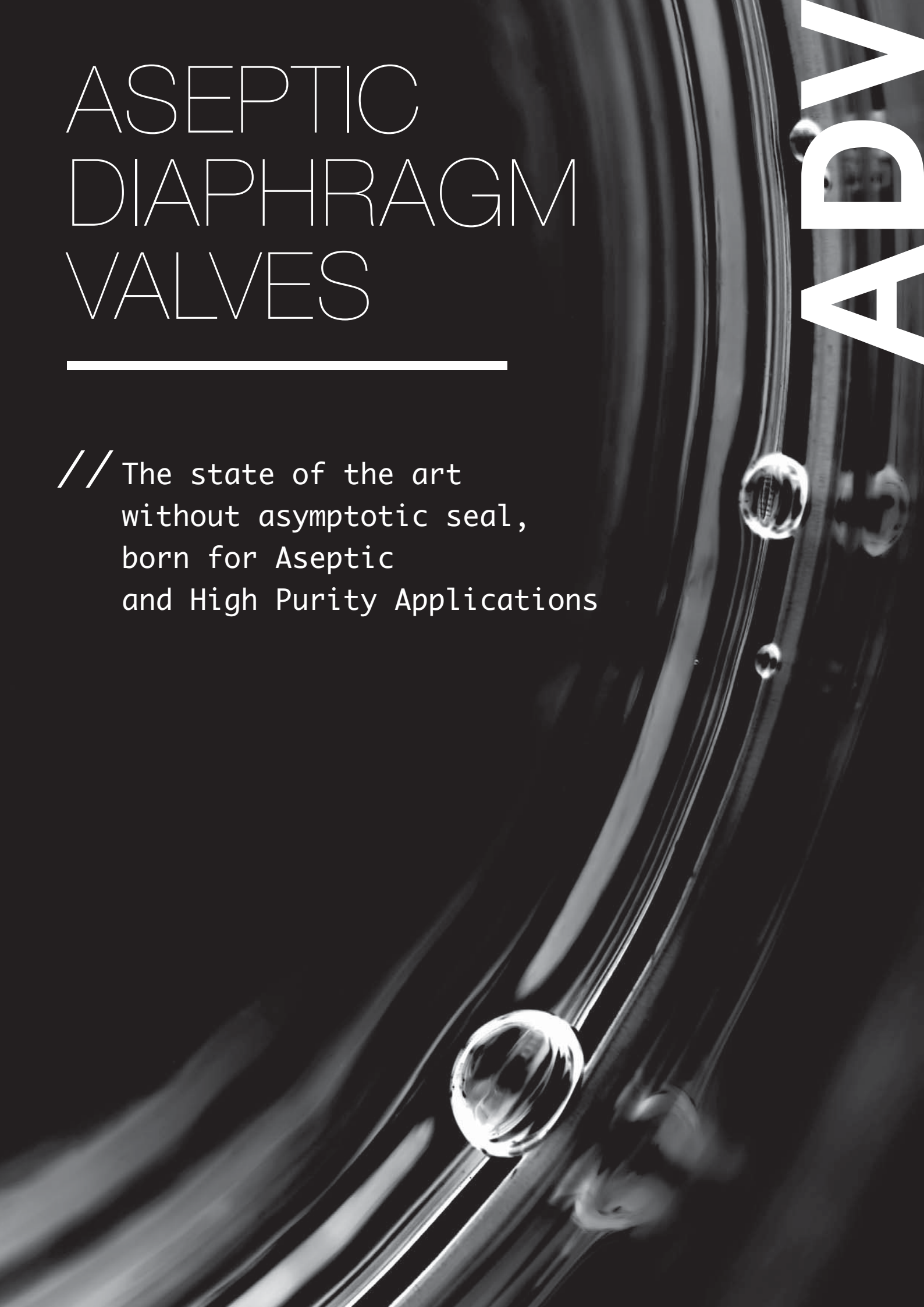

PATENTED

061

ART.

ASEPTIC DIAPHRAGM VALVES



DISC ASEPTIC DIAPHRAGM VALVES

Characteristics: Engineered and patented aseptic valves for biotechnology and semiconductor industries, pharmaceutical, food and medical processes. Designed for Aseptic and High Purity Applications. Two material: PTFE and AISI 316 L without asymptotic seals. Innovative internal design with inclined contact surfaces to drain the fluid. Fully autoclavable.

Documentation: Laser marking for traceability and validation processes. Material 3.1 certificates, FDA or USP, internal surface finishing check as standard.

1 TRI-CLAMP



ART. 061/A
P. 006



ART. 061/H
P. 008



ASTM A270 Tri-Clamp

Size	Ø A	Ø Di	L	Valve Material	Diaphragm Material	Code
1/2"	25,00	9,40	88,90	1.4404	PTFE - USP 121	061A60050PT121
3/4"	25,00	15,75	101,60	1.4404	PTFE - USP 121	061A60075PT121
1"	50,50	22,10	114,30	1.4404	PTFE - USP 121	061A60100PT121
1.1/2"	50,50	34,80	139,70	1.4404	PTFE - USP 121	061A60150PT121
2"	64,00	47,50	171,00	1.4404	PTFE - USP 121	061A60200PT121
2.1/2"	77,40	60,20	222,00	1.4404	PTFE - USP 121	061A60250PT121

Int. finishing: $Ra \leq 0,4 \mu m$ Ext. finishing: $Ra \leq 0,8 \mu m$ Mirror Polished

Max Working Conditions:

10 bar (150 psi) and 150°C (300°F)

Gaskets:

121° PTFE

Installation:

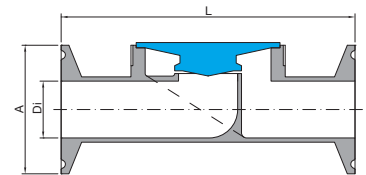
Vertical installation recommended

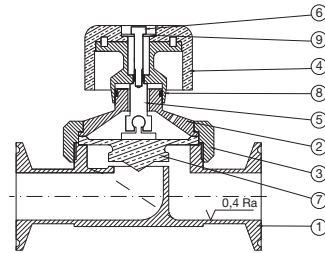

N°	Name	Material
1	Body	AISI 316L
2	Cover	AISI 316L
3	Ring	AISI 316L
4	Handle	PTFE + AISI 316L
5	Connecting Rod	COATED AISI 316L
6	Special Screw	AISI 304
7	Diaphragm	PTFE + AISI 316L or GUAFLON + AISI 316L
8	O-Ring	FPM/FKM
9	Special Washer	AISI 304

N°	Description	Valve size	Code
2	Cover n° 1 pcs	1/2"	AAAA0345
		3/4"	AAAA0345
		1"	AAAA0333
		1.1/2"	AAAA0328
		2"	AAAA0303
		2.1/2"	AAAA0317
3	Ring n° 1 pcs	1/2"	AAAA0344
		3/4"	AAAA0344
		1"	AAAA0344
		1.1/2"	AAAA0322
		2"	AAAA0302
		2.1/2"	AAAA0318
4	Handle n° 1 pcs	1/2"	0616005004PT70
		3/4"	0616005004PT70
		1"	0616005004PT70
		1.1/2"	0616015004PT70
		2"	0616015004PT70
		2.1/2"	0616025004PT70
5	Connecting Rod n° 1 pcs	1/2"	AAAA0409
		3/4"	AAAA0409
		1"	AAAA0409
		1.1/2"	AAAA0410
		2"	AAAA0410
		2.1/2"	AAAA0410
6	Special Screw n° 2 pcs	1/2"	061VITEM4X25
		3/4"	061VITEM4X25
		1"	061VITEM4X25
		1.1/2"	061VITEM6X30
		2"	061VITEM6X30
		2.1/2"	061VITEM6X30

N°	Description	Valve size	Code
7	PTFE - USP 121° Diaphragm n° 1 pcs	1/2"	0616005007PT121
		3/4"	0616005007PT121
		1"	0616010007PT121
		1.1/2"	0616015007PT121
		2"	0616020007PT121
		2.1/2"	0616025007PT121
8	O-Ring n° 5 pcs	1/2"	061X005008V
		3/4"	061X005008V
		1"	061X005008V
		1.1/2"	061X015008V
		2"	061X015008V
		2.1/2"	061X015008V
9	Special Washer n° 2 pcs	1/2"	061ROND15.7X4.4
		3/4"	061ROND15.7X4.4
		1"	061ROND15.7X4.4
		1.1/2"	061ROND24.0X6.5
		2"	061ROND24.0X6.5
		2.1/2"	061ROND24.0X6.5
2+	Complete Handle n° 1 pcs	1/2"	061A6005002
3+		3/4"	061A6005002
5+		1"	061A6010002
6+		1.1/2"	061A6015002
8+		2"	061A6020002
9		2.1/2"	061A6025002



ASTM A270 Tri-Clamp

Size	Ø A	Ø Di	L	Valve Material	Diaphragm Material	Code
1/2"	25,00	9,40	88,90	1.4404	PTFE - USP 121	061H60050PT121
3/4"	25,00	15,75	101,60	1.4404	PTFE - USP 121	061H60075PT121

Int. finishing: **Ra ≤ 0,4 µm**
Ext. finishing: **Ra ≤ 0,8 µm Mirror Polished**

Max Working Conditions:
10 bar (150 psi) and 150°C (300°F)

Installation:
Vertical installation recommended

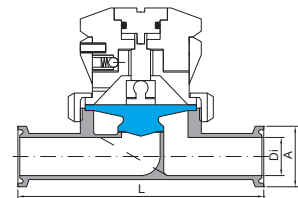

Spare parts

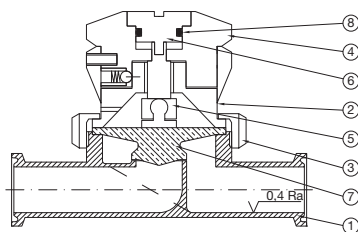

N°	Name	Material
1	Way Body	AISI 316L
2	Cover with adjustable regulator	AISI 316L
3	Ring	AISI 316L
4	Handle	AISI 316L
5	Connecting Rod	COATED AISI 316L
6	Special Screw	AISI 304
7	Diaphragm	PTFE + AISI 316L
8	O-Ring	FPM/FKM

N°	Description	Valve size	Code
3	Ring n° 1 pcs	1/2"	AAAA0344
		3/4"	AAAA0344
5	Connecting Rod n° 1 pcs	1/2"	AAAA0409
		3/4"	AAAA0409
7	PTFE - USP 121° Diaphragm n° 1 pcs	1/2"	0616005007PT121
		3/4"	0616005007PT121
8	O-Ring n° 5 pcs	1/2"	061X005008V
		3/4"	061X005008V
2+3+4+5+6+8	Complete Handle n° 1 pcs	1/2"	061H6005002
		3/4"	061H6005002

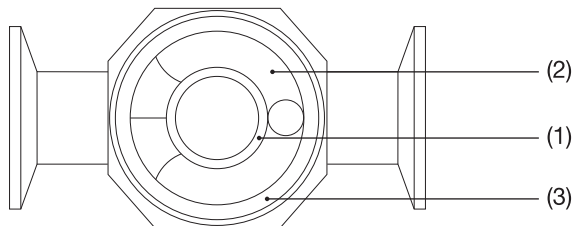
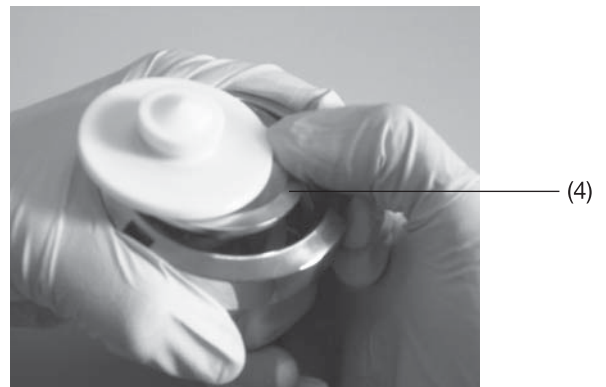
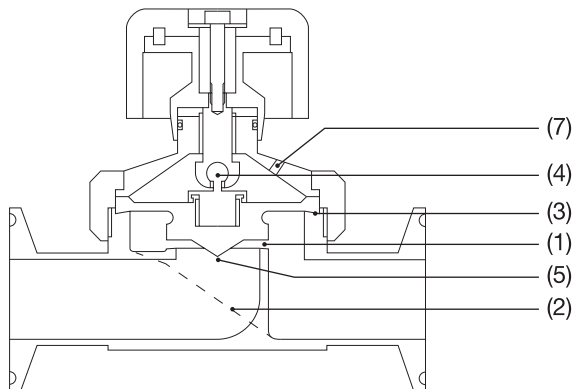

The opening and closing movements do not detect the areas which are away from the shutter's contact surface, which however, is inclined and it allows the draining of the fluid outwards during the support movement and the tightness of the diaphragm on the work table shutting surface (1).

The internal chute allows the valve's chamber to easily empty itself even during horizontal use (2).

The inverse taper of the tightness surface in correlation with the diaphragm's surface sustain allows for concentrated tightness on the internal edge, which is in contact with the product, it is secured by a strong and optimal compression, and it is performed by the external roller (3).

In order to guarantee the maximum quality, the central body is totally machine-manufactured, using welded Tri-Clamp connections, available with internal finishing under 0.4 Ra. The diaphragm is manufactured in PTFE, which is appropriately connected to the AISI316L traction-compression systems, therefore there is no possibility of by-passing, and it has a spherical conformation which makes the replacing maneuver easy (4).

The runner in the shutter makes any eventual needs to regulate the fluid more precise (5).

The manual control of the valve is carried out through a PTFE handle. For precision regulation purposes, a manual, self-locking actuator is available (Type H); it includes 80 different positions, as well as a position indicator, which is available only for 1/2" and 3/4" (6).

The hole on the head-frame valve allows the external display of any possible cracks on the diaphragm (7).